



SIM7020 Series_SUB KIT_User Guide

Version: 1.02

Release Date: May 30, 2019

About Document

Document Information

Document	
Title	SIM7020 Series_SUB KIT_User Guide
Version	1.02
Document Type	Instructions
Document Status	Released/Confidential

Revision History

Revision	Date	Owner	Status / Comments
1.00	Jun 11, 2018	Ming,Zhu	First Release.
1.01	Aug 08, 2018	Light, Wu	Revised
1.02	May 30, 2019	Olivier, Wu	Revised

Related Documents

[SIM7020 Hardware Design_V1.02](#)
[SIM7020G Hardware Design_V1.00](#)
[SIM7020 Series_AT Command Manual_V1.03](#)
[SIM7020 Series_Low Power Mode_Application Note_V1.03](#)
[SIM7020 Series_TCPIP_Application_Note_V1.02](#)
[SIM7020 Series_FOTA_Application_Note_V1.01](#)
[SIM7020 Series_Genie_Logging_Tool_User_Guide_V1.0](#)

This document applies to the following products:

Name	Type	Size (mm)	Comments
SIM7020C	NB	17.6*15.7	Band 1/3/5/8
SIM7020E	NB	17.6*15.7	Band 1/3/5/8/20/28
SIM7020G	NB	17.6*15.7	Band 1/2/3/4/5/8/12/13/17/18/19/20/25/26/28/66/70/71/85

Copyrights

This document contains proprietary technical information which is the property of SIMCom Wireless Solutions Co.,Ltd. Copying of this document and giving it to others and the using or communication of the contents thereof, are forbidden without express authority. Offenders are liable to the payment of damages. All rights reserved in the event of grant of a patent or the registration of a utility model or design. All specification supplied herein are subject to change without notice at any time.

Contents

About Document	2
Document Information.....	2
Revision History.....	2
Related Documents	2
Contents.....	3
1 Purpose of this document	4
2 Evaluation Board Overview	4
2.1 SIM7020 SUB KIT Overview.....	4
2.2 Interface Introduction	5
3 Installations and Communication	7
3.1 Driver installation	7
3.1.1 USB-to-UART interface driver installation	7
3.1.2 Module USB interface driver installation	7
3.2 Accessories installation	8
3.3 AT command Communication	8
3.3.1 Power on device	8
3.3.2 Communication through UART interface	8
4 Firmware Update.....	9
5 Power Consumption HW Test Set Up	11
Contact.....	13

1 Purpose of this document

With SIM7020 SUB KIT, developer could verify each function quickly and easily.

This document is aim to introduce every interface usage of this SUB kit, and send AT command to demo module functions.

2 Evaluation Board Overview

2.1 SIM7020 SUB KIT Overview

Here is an overview of the total SUB KIT package.

SUB kit package list is following,

- 1) SIM7020x-SUB (x stands for C/E/G)
- 2) Micro USB cable
- 3) LTE antenna

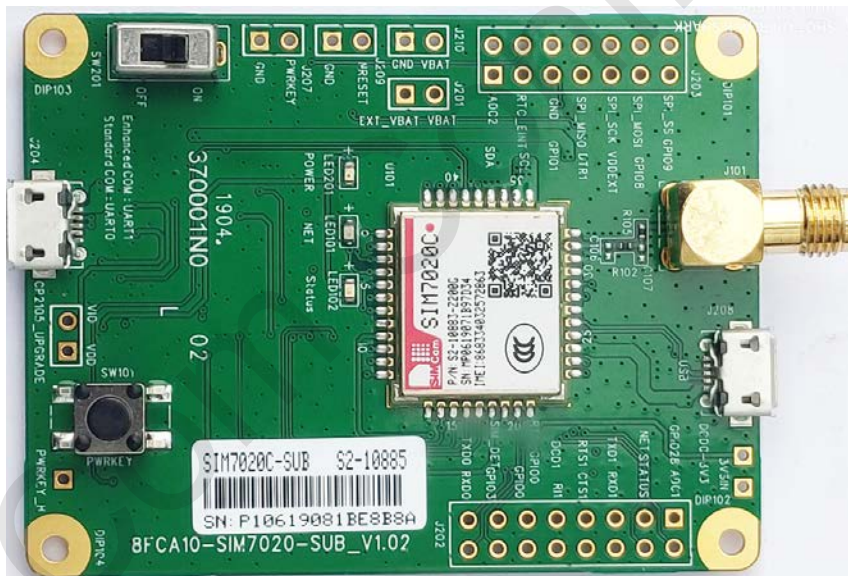

Here is the bottom view of SIM7020x-SUB.

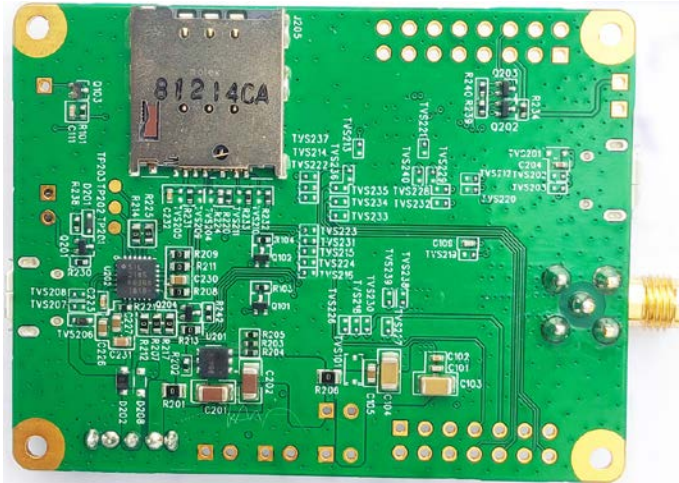

In order to get proper part to do the evaluation test, here is brief list for SIM7020x-SUBKIT part numbers.

Kit type	Part Number	Comments
SIM7020C-SUBKIT	S2-10886	For China
SIM7020E-SUBKIT	S2-107ZG	For Europe, Australia and South Asia etc.
SIM7020G-SUBKIT	S2-1088A	For Global

2.2 Interface Introduction

From above overview on the SIM7020x-SUB, we can see many signal interfaces, communication ports and antenna interface. Now, we will describe them in detail.

Index	Position	Description
A	Uxxx	SIM7020x Module
B	SW101	PWRKEY Button
C	J205	SIM Card holder
D	J204	<ol style="list-style-type: none"> UART ports of SIM7020x, for AT communication and FW update. Power Supply
E	SW201	Power Switch (UP is ON, POWER red LED201 light)
F	J208	USB port of SIM7020x, for debugging
G	J101	LTE antenna SMA connector
H	J209	Reset and GND reserve locations, for resetting the module
I	J203(Pin7,Pin9)	DTR and VDD_EXT reserve locations, for sleep mode (AT+CSCLK=1), (J203 square hole is pin 1)
J	J203(Pin4,Pin6)	RTC_EINT and GND reserve locations, for waking up module from the PSM mode, (J203 square hole is 1 pin)
K	J210	VBAT test point

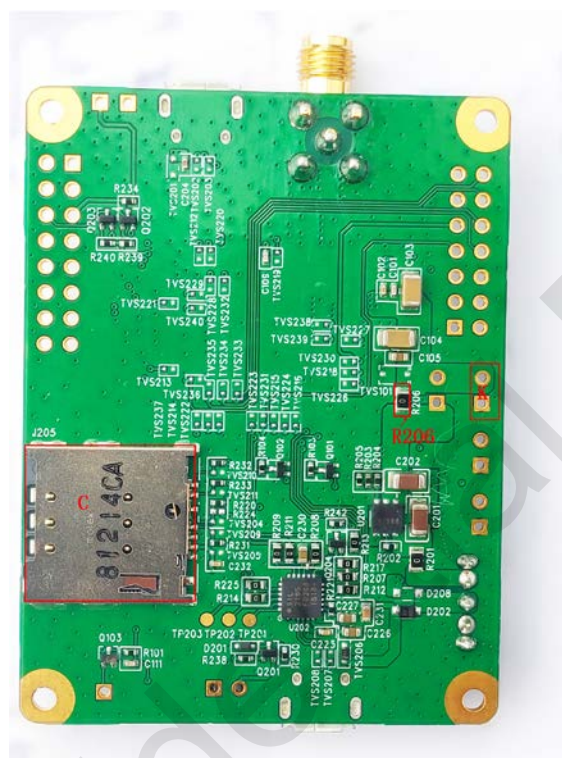
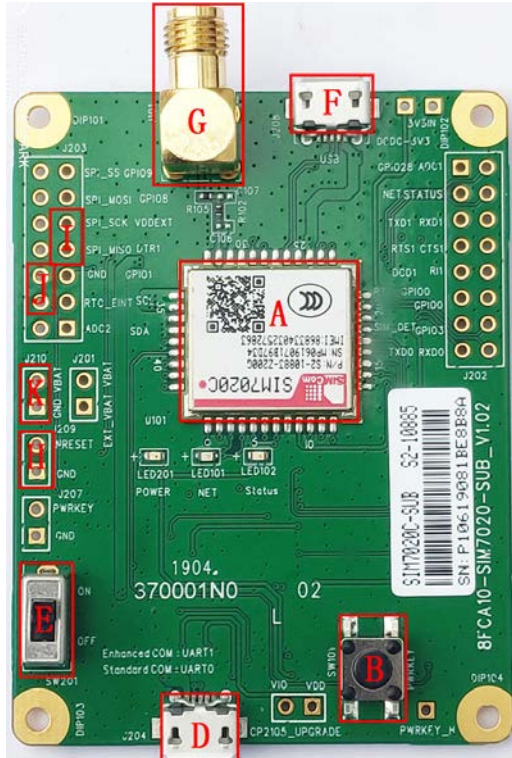

SW201 Power Switch

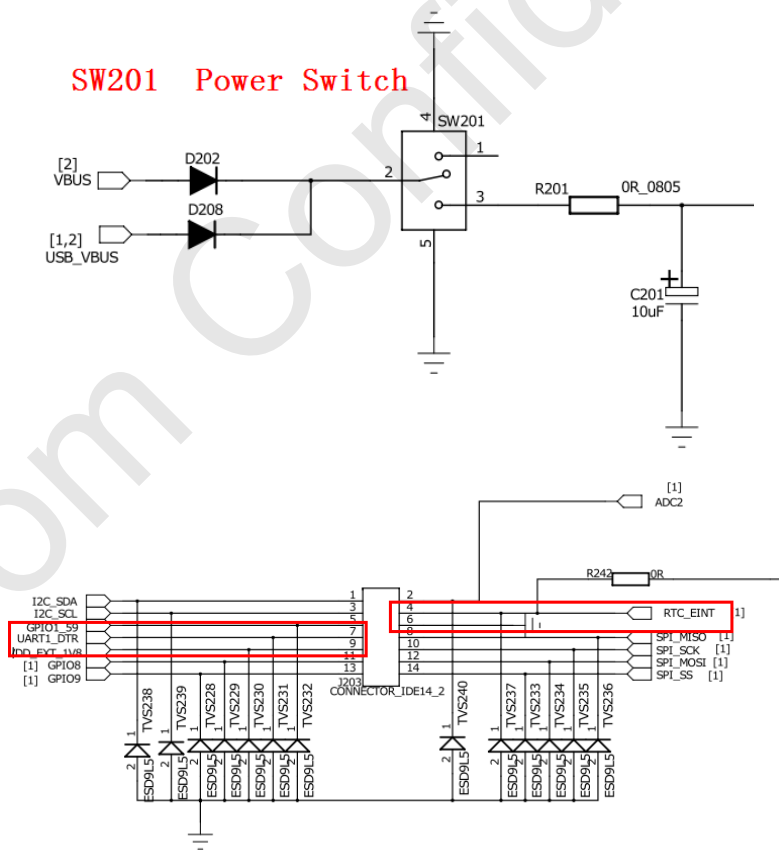

Note: For the detail about [SIM7020-SUB_V1.02](#) board schematic, please contact with SIMCom support team.

※ Notice

- ✘ Module VBAT range is from 2.1V to 3.6V, typical is 3.3V recommended.
- ✘ Module GPIO pins are at 1.8V logical level. Cannot be connected to external 3.0V or higher level signals directly.
- ✘ SIM7020C and SIM7020E module support CAT-NB1, SIM7020G module supports CAT-NB1/CAT-NB2 (3GPP Release 14).

3 Installations and Communication

3.1 Driver installation

There are two USB jacks, one is USB to UART (position **D**), and the other one is USB (position **F**).



3.1.1 USB-to-UART interface driver installation

This USB-to-UART chipset on board is from Silicon labs.

Here is the driver link.

<https://www.silabs.com/products/development-tools/software/usb-to-uart-bridge-vcp-drivers>

After driver installed properly and completely, there are two virtual USB ports, for example COM24 and COM23 as below.



- ▼ 端口 (COM 和 LPT)
 -  Silicon Labs Dual CP210x USB to UART Bridge: Enhanced COM Port (COM24)
 -  Silicon Labs Dual CP210x USB to UART Bridge: Standard COM Port (COM23)

Interface	Number	SIM7020 UART	Comments
Enhanced	COM 24	UART1	Full mode for AT communication
Standard	COM 23	UART2	No hardware flow control, for FW update

3.1.2 Module USB interface driver installation

SIM7020 Chipset is from MTK (MediaTek). SIMCom provide proper driver to developer, please contact SIMCom Support Team.

After USB driver installed properly and completely, there will be 2 virtual ports, debug port and modem port.

-  MTK USB Debug Port (COM30)
-  MTK USB Modem Port (COM29)

USB interface is used for taking **genie** (debug) log only.

Notes: For the detail, please refer to “SIM7020 Series_Genie_Logging_Tool_User_Guide_V1.0”.

3.2 Accessories installation

Now, in order to do the functional test, necessary accessories need to be installed into SIM7020 SUB board.

- 1) Insert **NB-IOT** SIM card to sim card slot (Position **C**);
- 2) Install LTE antenna (Position **G**);
- 3) Insert micro USB cable to USB jack (Position **D**) for power supply and UART (AT and FW update) communication;
- 4) Insert micro USB cable to USB jack (Position **F**) for taking genie log. (**Option**)

Notes: When USB jack (Position **F**) is connected to the PC, SIM7020 can't enter into PSM mode.

3.3 AT command Communication

3.3.1 Power on device

- 1) Switch “Power Switch” (Position E) to ON, then POWER red LED will light, which means VBAT power is on.
- 2) Press “PWRKEY” button (Position B) for one second to power up SIM7020.

Now **POWER** red LED is solid on, **Status** blue LED will light, **NET** green LED is blinking with below behaviors.

NET+ (Network LED)	Status Description
64ms on, 800ms off	Network scanning, not registered
64ms on, 3000ms off	Registered network (PS service)
64ms on, 300ms off	Data communication
OFF	Power off or in PSM mode

3.3.2 Communication through UART interface

SIM7020 UART communication supports auto baud rate, as well as other baud rates up to 3Mbps.

Here take Putty for example, configure serial port with COM24, 115200bps-8-1-N.

- ▼ 端口 (COM 和 LPT)
 - 🖨️ Silicon Labs Dual CP210x USB to UART Bridge: Enhanced COM Port (COM24)
 - 🖨️ Silicon Labs Dual CP210x USB to UART Bridge: Standard COM Port (COM23)

Interface	Number	SIM7020 UART	Comments
Enhanced	COM 24	UART1	Full mode for AT communication
Standard	COM 23	UART2	No hardware flow control, for FW upgrade

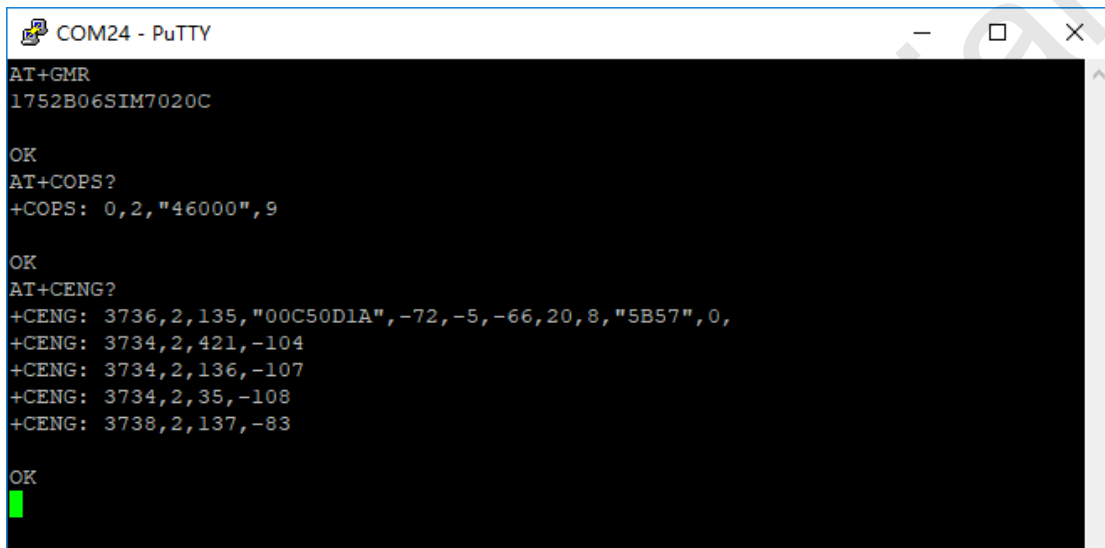

4 Firmware Update

- 1) Insert micro USB cable to USB jack (position **D**) and connect to the PC.
- 2) Open Windows flash tool **SIM7020 QDL V1.01 Only for Update** as show below.

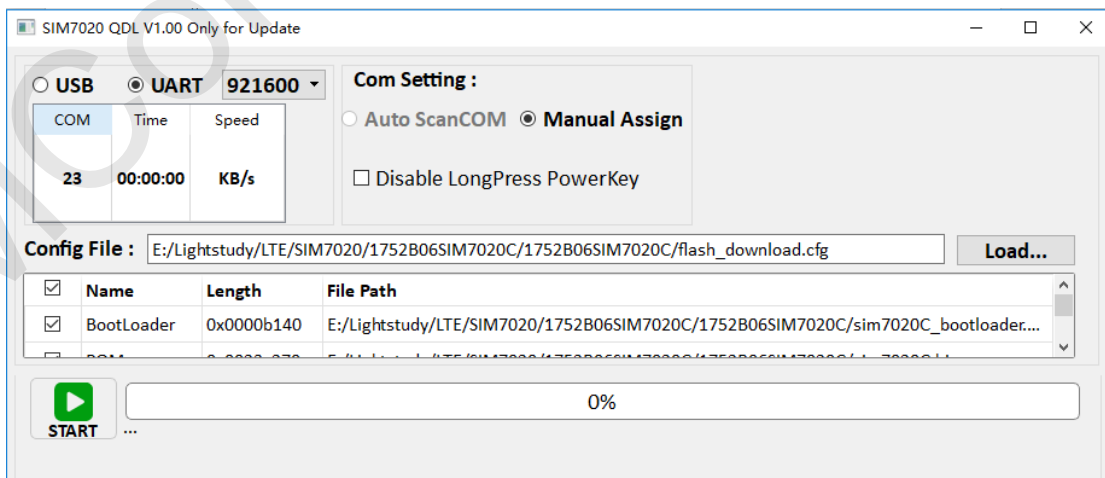

FW update Tool

- 3) Select “UART” and baud rate “921600”.
- 4) Double click the “COM” port part and enter the right COM port number (23 in following example), the “Standard COM port” is used for FW update.



▼ 端口 (COM 和 LPT)

- ☐ Silicon Labs Dual CP210x USB to UART Bridge: Enhanced COM Port (COM24)
- ☐ Silicon Labs Dual CP210x USB to UART Bridge: Standard COM Port (COM23)

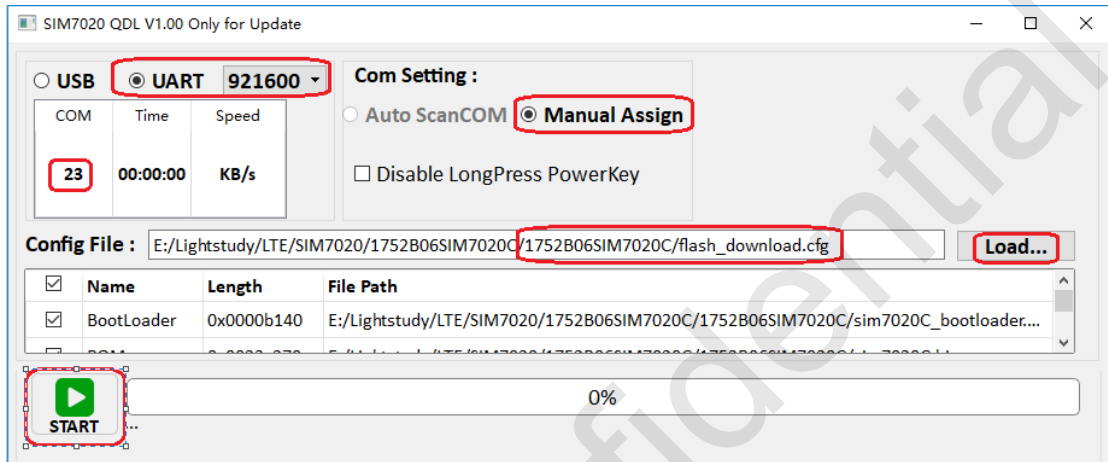
- 5) Click “Load” button and assign correct file path (.cfg file is inside the FW package).



- 6) Switch “Power Switch” (Position E)  to UP, then PWRER red LED will light, which means VBAT power is on.

- 7) Press “Start” button , then press the “PWRKEY” button  for one second. And then it will do the FW update automatically.

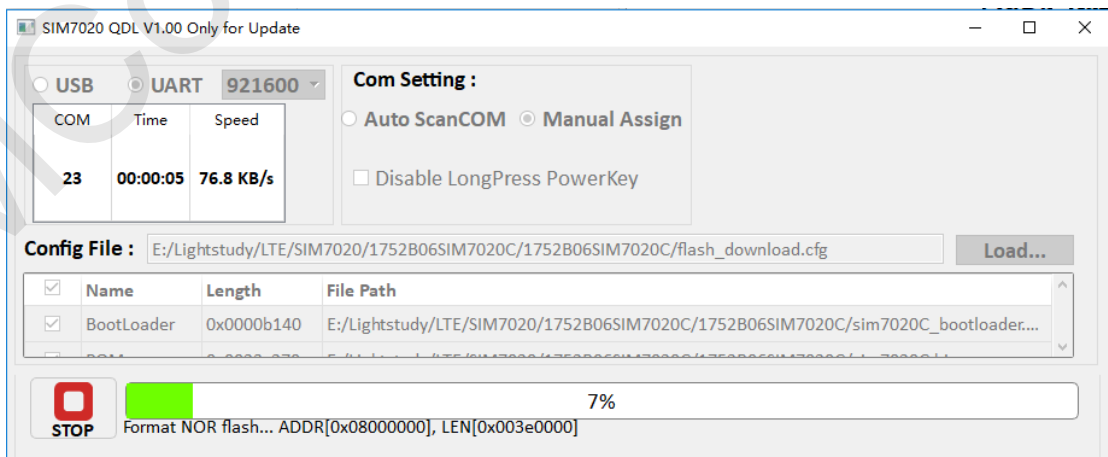

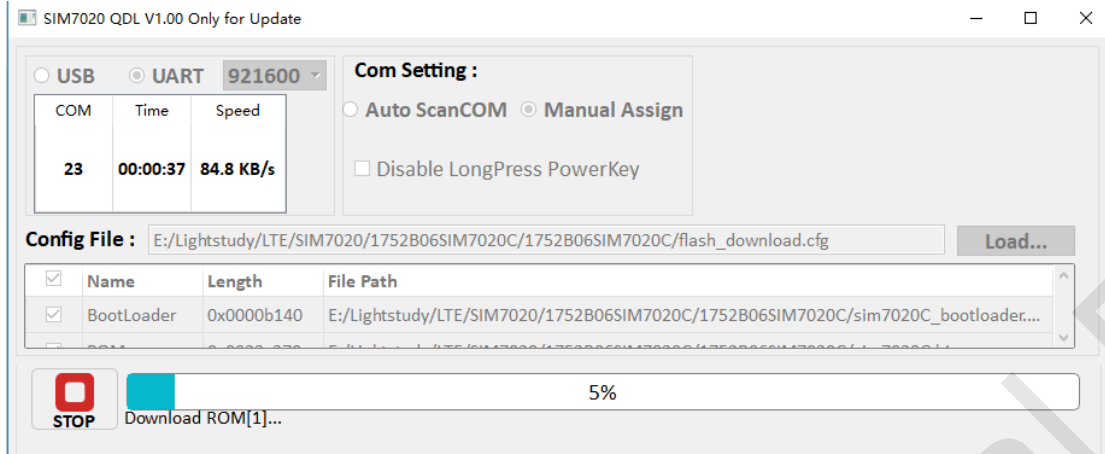

FW update ongoing

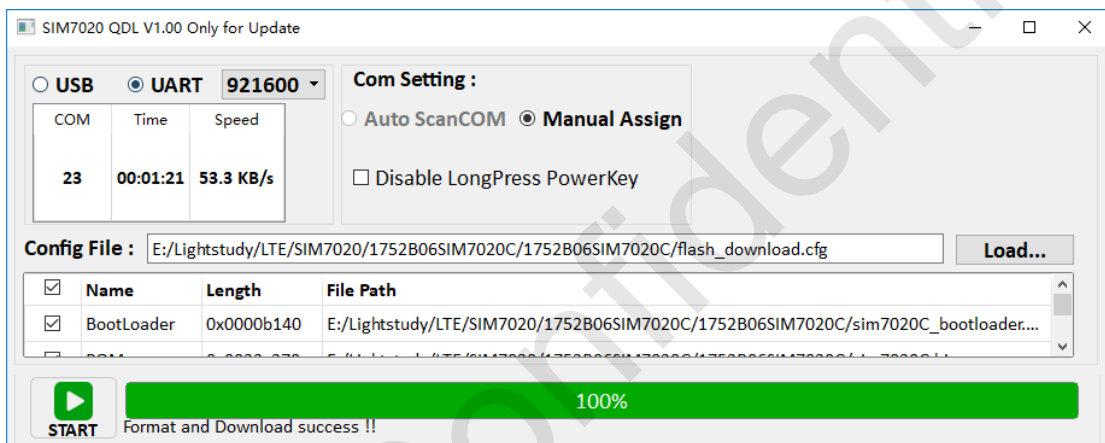

FW update finished

5 Power Consumption HW Test Set Up

- 1) Delete R206 on SIM7020 SUB board
- 2) Connect external power supply to VBAT & GND pads/Location K (for SIM7020 module only)

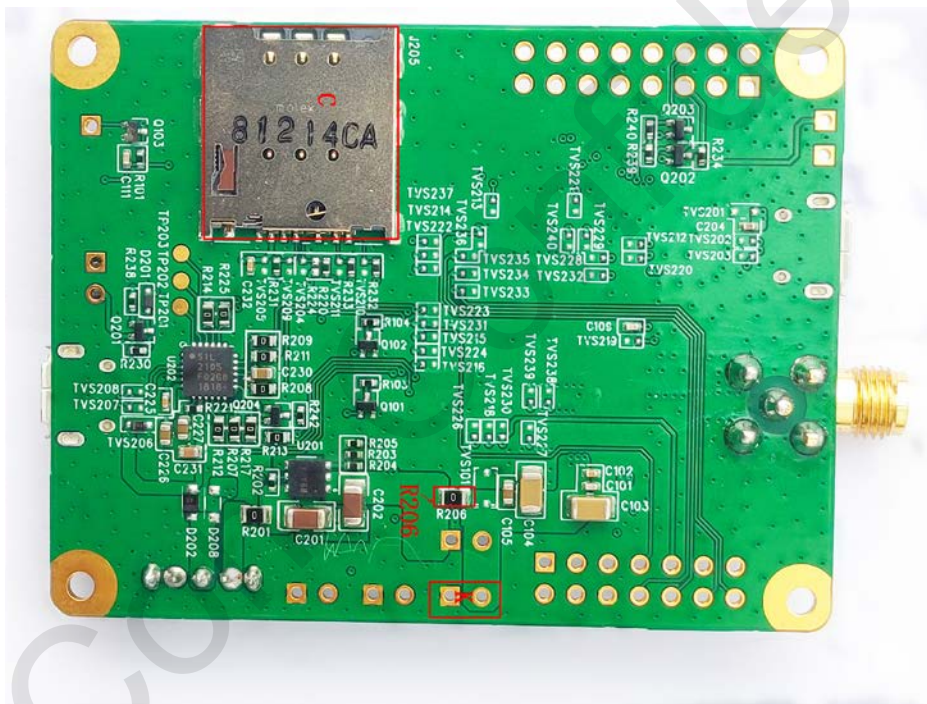
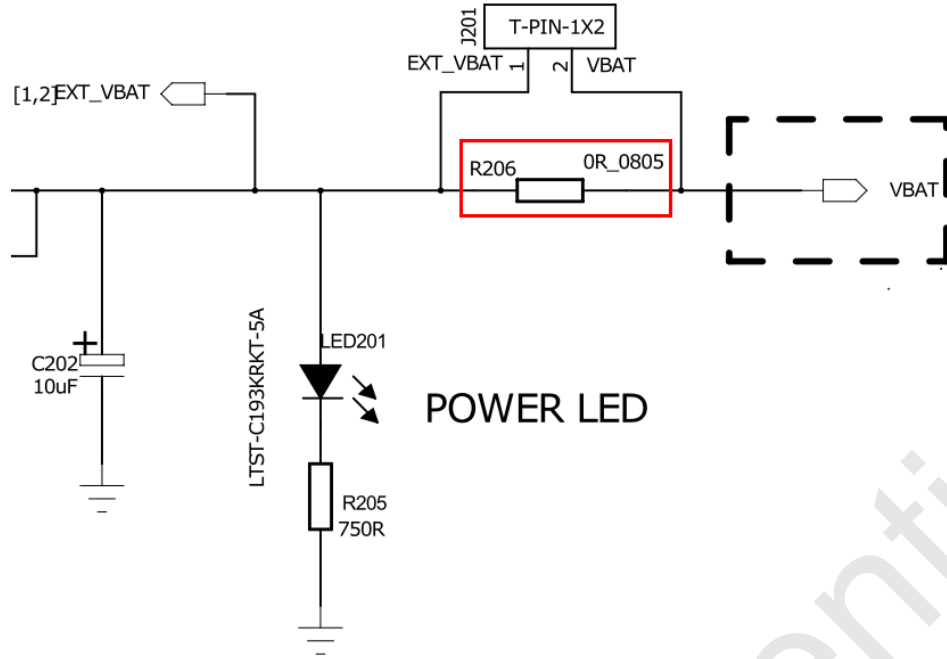

Notes: For the detail, please refer to "SIM7020 Series_Low Power Mode_Application Note_V1.03".

Contact

SIMCom Wireless Solutions Co.,Ltd

Address: Building B, 6F, No.633 Jinzhong Road, Changning District, Shanghai P.R.China 200335

Tel: +86 21 3157 5126

Email: support@simcom.com

Website: www.simcom.com